



STAGE IV[®] - Millennium 3
STAGE IV - Millennium Plus

**3-Zone Pressure
Relief Systems**

Operating Instructions

Revision 101204-UL2601

SenTech Medical Systems

 **WARNING**

Before operating this medical equipment, it is important to read this manual and to understand the operating instructions and safety precautions.

Failure to do this could result in patient injury and/ or damage to the product. If you have any questions, please contact SenTech Medical Customer Service at **800-474-4225** or **954-739-4972**.

Table of Contents

	<u>Page</u>
1.0 Safety Precautions	4
2.0 Product Overview	6
3.0 Installation	7
4.0 Operation	9
5.0 Maintenance And Cleaning	19
6.0 Troubleshooting Guide	23
7.0 Product Specifications	25
8.0 Warranty Information	26
9.0 Product Return	27

1.0 SAFETY PRECAUTIONS –

CAUTION! Certain medical conditions and treatments are **contraindicated** for use of the STAGE IV MILLENNIUM 3 AND PLUS SYSTEMS (“MILLENNIUM SYSTEMS”). **Always consult with the patient’s physician before placing a patient on an Alternating Pressure system.**

CAUTION! Bed frames used with the MILLENNIUM SYSTEMS can vary greatly depending on the specific health care setting, e.g., hospitals, nursing homes, home care, etc. Therefore, it is the responsibility of the caregiver to take the necessary precautions to ensure the safety of the patient. This includes, but is not limited to, the appropriate use of side rails to prevent falls and/or patient entrapment.

Electronic Controller –

DANGER!

- Do not use in the presence of flammable anesthetics. **Risk of explosion can result.**
- Only plug into a grounded “hospital grade” power receptacle and use the power cord supplied with the MILLENNIUM SYSTEMS.
- Exposure of the electronic controller to any liquid while it is plugged in could result in a severe electrical hazard.
- Only use fuses that have the same specified rating (**See Section 7.0 Product Specifications**). Using fuses with higher ratings could result in damage and/or injury.

CAUTION!

- The 120 VAC, 60 Hz models of the MILLENNIUM SYSTEMS incorporate fusing only in the ungrounded phase conductor. **These products must not be used in countries other than the United States or Canada.** They must be used in health facilities on grounded systems where conditions of maintenance and supervision ensure that only qualified persons will service the electrical distribution system.
- The STAGE IV MILLENNIUM 3 AND PLUS are separate systems. Do not interchange electronic controllers and mattresses.
- The electronic controller is a precision electronic product. Use care when handling or transporting. Dropping, or other sudden impacts, may result in damage to the controller.

CAUTION!

- Risk of Electric Shock. **DO NOT OPEN.** Do not attempt to repair or service the electronic controller. Repairs and service should only be done by SenTech Medical Systems. If the controller is not functioning properly, or has been damaged, unplug the unit and take it out of service immediately. Contact Customer Service at **800-474-4225** or **954-739-4972** for repair and service information.

Electronic Controller (Continued) –

IMPORTANT!

- Do not return a product for any reason without first contacting Customer Service to obtain return authorization (**See Section 9.0**).
- Do not place any objects/items, such as blankets, on, or over, the electronic controller. Excessive weight on the controllers could result in damage to the electronic controller.
- After exposure to extreme high or low temperatures, allow electronic controller to equilibrate to room temperature before operating.
- The controllers circulates room air during operation. Exposure to smoke may cause the system to fail. Therefore, smoking by patients, or visitors, while using the MILLENNIUM SYSTEMS is strongly discouraged.
- The power cord to the electronic controller should be positioned to avoid a tripping hazard and/or damage to the cord. SenTech recommends placing the cord under the bed frame and attaching it to an electrical outlet by the head of the bed.

2.0 PRODUCT OVERVIEW

The STAGE IV MILLENNIUM 3 AND PLUS are microprocessor controlled therapeutic mattress systems that provide 3-zone **Alternating Pressure** and **Low Air Loss (LAL)** therapies for the treatment and/or prevention of pressure wounds. These therapies can be combined or operated independently from each other. The STAGE IV MILLENNIUM 3 is designed to accommodate patient weights up to 500 lbs. and the STAGE IV MILLENNIUM PLUS is designed for bariatric patients weighing up to 995 lbs.

The Alternating Pressure feature provides pressure relief by deflating and inflating every other air cell on a timed interval. It is widely recognized that constant pressure to a bony prominence is a leading cause of skin breakdown. The MILLENNIUM SYSTEMS provide continuous movement of air cells that alleviates constant pressure and enhances circulation. The deflated air cells provide pressure relief, while the inflated air cells support the patient's weight.

The electronic controllers provide a "real-time" display of air pressure for both the inflated and deflated air cells. The amount of pressure to support a patient can be set automatically based on the patient's height and weight or can be manually set for custom configurations. All settings are stored in non-volatile memory. If power is interrupted, the electronic controller automatically returns to the previous settings when the power returns.

The Controlled Low Air Loss (LAL) feature on the MILLENNIUM SYSTEMS provide an optimum environment to assist in patient healing and comfort. LAL therapy is delivered through a patented SenTech Coverlet that provides a flow of diffused air directly to the patients skin through thousands of microscopic micro-vents. In addition, the mattress has been designed to provide an anti-shear/anti-friction surface for patients.

3.0 INSTALLATION –

NOTE: It is recommended that all shipping and packing material be saved in the event that the product has to be sent back to SenTech Medical.

3.1 Unpacking and Inspection -

Carefully remove the controller, mattress and all accessories from the shipping cartons. Inspect all items for any damage that may have occurred during shipping. Any damages, or missing components, should be reported to SenTech Customer Service as soon as possible.

Mattress Replacement: The box contains a completely assembled mattress replacement system. This system consists of:

- 1.5 Inch Foam Mattress
- Air Cell Assembly
- Top Coverlet with Low Air Loss Hose
- CPR Hose Assembly

Electronic Controller: The electronic controller is in a separate box containing:

- Electronic controller
- Power cord
- Operating Instructions

3.2 Installation –

STAGE IV Millennium systems are designed to operate in a controlled environment, which is free from extreme temperatures, high humidity and/or excessive amounts of airborne particulates, such as dust and smoke.

1.2.1 Mattress Replacement:

1. Unroll the mattress replacement.
2. Remove the current mattress from the bed frame and replace with a STAGE IV MILLENNIUM Mattress assembly.
3. Position mattress and hoses so that the:
 - CPR hose assembly is to the left of the footboard
 - Low Air Loss (LAL) hose is to the right of the footboard
4. Ensure CPR hose assembly is attached by inserting the hose assembly into the socket on the mattress and turning counterclockwise $\frac{1}{4}$ of a turn until it stops.
5. There are two (2) sets of straps with D-rings on each side of the mattress and one (1) at the head of mattress. Use these straps to secure the mattress replacement to the bed frame.

IMPORTANT: Make sure that the attachment of the mattress does not interfere with the bed movement or operation.

3.2.2 Electronic Controller:

1. Hang the controller on the outside edge of the footboard on the bed frame.
2. Attach the six (6) color-coded hoses to the corresponding color-coded connectors on the left side of the controller i.e., red to red, green to green, etc. (See Diagram 1 Below).
3. Attach the LAL hose to the single connector on the right side of the controller. (See Diagram 2 Below).
4. Plug into a grounded 120 Vac 60 Hz electrical outlet.

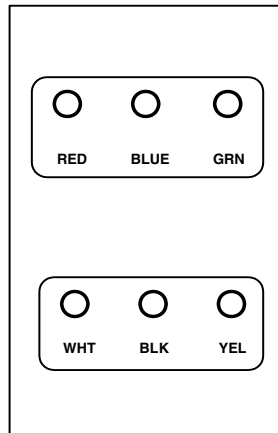

DIAGRAM 1

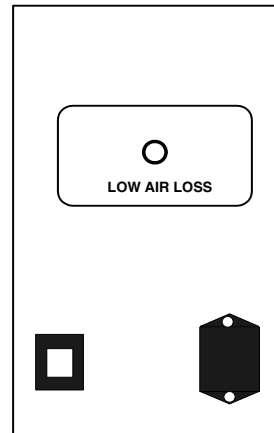

DIAGRAM 2

4.0 OPERATION –

4.1 Key Functions and Settings:

Control Panel: The STAGE IV MILLENNIUM 3 control panel is shown in **Diagram 3** below. Stage IV MILLENNIUM PLUS controller operates exactly like the STAGE IV MILLENNIUM 3, but has an extended weight range to accommodate bariatric patients.

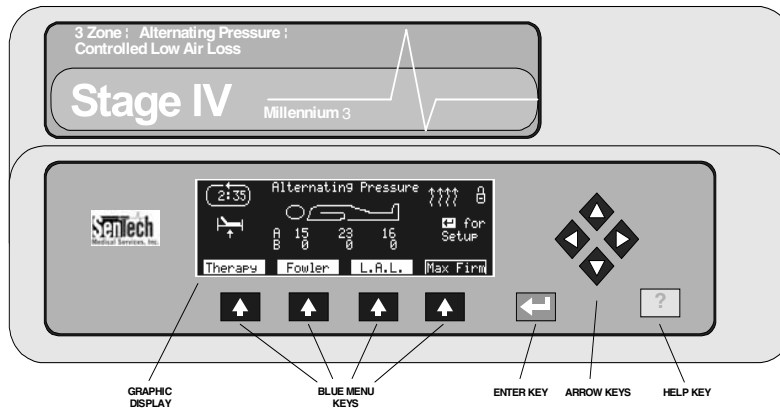

DIAGRAM 3

Keys:

ENTER KEY (Green) Takes you into and out of the SET UP screen.

HELP KEY (Yellow) ? Accesses HELP screens.

ARROW KEYS (Maroon)  Tabs through the SET UP menu.

MENU KEYS (Blue)  Selects MENU options.

Power Switch: This Switch is located next to the electrical cord on the bottom right side of the unit. It is used to control the AC power to the unit.

4.2 Basic Features:

- ALTERNATING PRESSURE:** Provides pressure relief therapy by inflating and deflating alternate air cells.
- FLOAT:** Provides a low pressure static surface.
- LOW AIR LOSS (L.A.L.):** Provides a gentle flow of air directly to patient's skin.
- MAX FIRM:** Provides a firm surface for patient transfer and medical treatment.
- LOCK:** Prevents inadvertent changes to the control panel.
- FOWLER BOOST:** Increases pressure in the Trunk zone for patients in an inclined position.
- DEFLATE:** Automatically deflates the mattress.

4.2.1 MAIN RUN SCREEN: The Main Run Screen has four (4) menu options. Press the blue MENU keys  to select the desired option. Selected options are highlighted when selected.

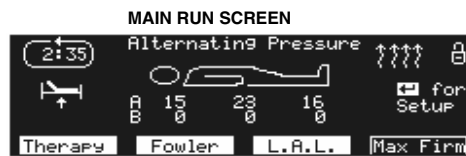

During normal operation, the following words appear above the four Menu Keys. Pressing a key results in the corresponding action.

- THERAPY** Pressing this key toggles the system between **Alternating Pressure** and **Flotation** therapy modes.
- FOWLER** Toggles the **Fowler Boost** on and off.
- L.A.L.** Toggles **Low Air Loss** (LAL) on or off.

4.2.1.1 THERAPY:

1. Press this blue MENU key  to select either **Alternating Pressure (AP)** or **FLOAT** modes.
2. This key remains "highlighted".

3. The table below shows the function of each therapy:

Float Mode	AP Mode
All air cells in each zone (Head, Trunk & Foot) are inflated to the selected pressure.	Alternate air cells in each zone are inflated to the selected pressure.
All air cells remain at the selected pressure.	On a timed cycle, alternate air cells sequentially inflate and deflate.
Pressure of all air cells in each zone is displayed on the screen.	Air pressure in the deflated and inflated air cells in each zone are displayed on the screen.
	Time remaining in the cycle is also displayed on the screen.

4.2.1.2 FOWLER BOOST: This feature allows the user to increase the pressure in the trunk zone for patients who are in an inclined, or Fowler position. Fowler Boost is designed to prevent patients from “bottoming out” when the weight is concentrated in the trunk area while in the inclined position.



1. Pressing the blue MENU key  underneath “FOWLER BOOST” increases the pressure in the trunk zone.
2. To adjust the percentage of Fowler Boost, see Advanced SETUP, Section 4.2.2.1.

4.2.1.3 LOW AIR LOSS (LAL): Provides a gentle flow of air through the coverlet.

1. Pressing the blue MENU key  underneath “LAL” turns the LAL on and off.
2. When LAL is on, the LAL on the screen is highlighted and the animated LAL icon is displayed.



NOTE: Air for LAL is delivered when the air cells are *not* being inflated.

4.2.1.4 MAX FIRM: Provides a flat stable surface for patient transfer and medical treatment.

1. Select MAX FIRM by pressing the blue MENU key  underneath the words “MAX FIRM”.
2. When the transfer/treatment is complete, return to desired mode of therapy by pressing appropriate MENU key . If system remains in MAX FIRM for more than 20 minutes (30 minutes for the Millennium Plus), it will revert to normal operation.

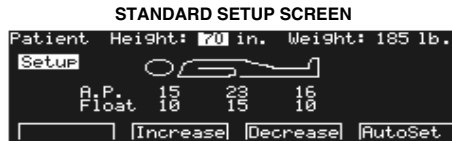
4.2.1.5 STANDARD SETUP –



1. Press the green ENTER key  to access SETUP screen. Setup instructions can be accessed by pressing the HELP key .
2. Set patient height using the INCREASE and DECREASE keys.
3. Use the maroon ARROW keys  to move cursor to weight.
4. Enter the patient's weight using the INCREASE and DECREASE keys.
5. Press AUTOSET key.

4.2.1.6 CUSTOM SETUP –

1. Use the maroon ARROW keys  to move the cursor to the desired zone (Head, Trunk or Foot).
2. Adjust pressure using the INCREASE and DECREASE keys.

NOTE: Do not press AUTOSET. Pressing AUTOSET will cause the system to revert to default pressures based on height and weight.

4.2.2 ALTERNATE MENU OPTIONS – These options can be accessed by pressing and holding the ENTER key .

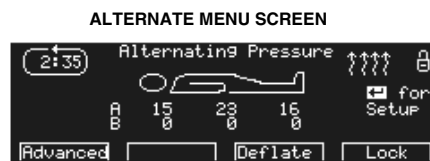

- ADVANCED** Accesses Advanced SETUP screen.
- DEFLATE** Deflates mattress automatically.
- LOCK** Locks and unlocks the control panel.

4.2.2.1 ADVANCED SETUP –

Advance setup allows adjustment of the following system parameters:

Parameter	Range Values		Default Values	
	Millennium 3	Millennium Plus	Millennium 3	Millennium Plus
MAX FIRM	32-60 mmHg	32-65 mmHg	40 mmHg	50 mmHg
Cycle Time	4-9 minutes	5-9 minutes	5 minutes	6 minutes
Fowler Boost	15-40%	15-40%	20%	30%

CAUTION: Only advanced users with proper training should use the Advanced Setup feature. Pressing the AUTOSSET will reset the system to the default settings.

ADVANCED SETUP SCREEN

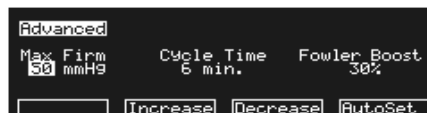



- INCREASE** Increases the highlighted parameter.
- DECREASE** Decreases the highlighted parameter.
- AUTOSET** Loads default settings.

1. Use the maroon ARROW keys  to move the cursor to the parameter to be changed.
2. Adjust the setting using the INCREASE and DECREASE keys.

4.2.2.2 DEFLATE FUNCTION –

Detach the LAL hose from the right side of the controller.
 Air will be evacuated from the mattress for a specified period of time:
 STAGE IV Millennium 3 = 15 minutes
 STAGE IV Millennium Plus = 20 minutes
 After the specified time, the pump will shut off.

4.2.2.3 LOCK – The lock feature prevents inadvertent modification of system settings. When LOCK is set, all key are disabled except for the HELP key and the key turn the lock feature off.

1. Press and hold the ENTER key .
2. When the menu changes, press the blue MENU key  underneath the word "LOCK" to lock and unlock the system setting.
3. The *lock icon* on the display panel indicates the lock status. If open, the system is unlocked. If closed the system is locked.

NOTE: The system always powers-up with the system unlocked.

4.2.3 HELP - Provides user assistance and system information:



1. To access the help feature, press the yellow HELP ? key.
2. There are three (3) options on the HELP screen:

PATIENT SETUP – Guide for system setup, including setting patient height and weight.

HELP TOPICS – General guide for system operation. Use maroon ARROW keys [Left] [Right] to tab through the help screens and green ENTER key [Enter] to exit HELP:

- **Therapy** – General description of therapy options.
- **Basics** – General setup instructions and a description of special modes/features.
- **Options** – Explains the Low Air Loss (LAL) and LOCK features.
- **Other** – Description of lock feature, system alarms and “replace filter” notification.

SYSTEM INFO – Displays hours of system operation since the date of manufacture and the software revision.

4.2.2 ALARM: Alarm will activate with an audio-visual indicator when air mattress does not reach required pressure within 20 minutes.

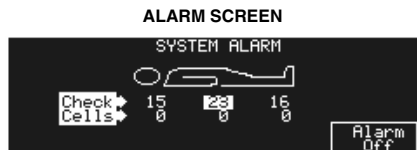

4.3 CPR OPERATION –

- 4.3.1 The *Low Profile CPR* provides caregiver with the ability to rapidly evacuate air from the support surface in emergency situations. The CPR is located at the foot of the mattress on the patient's right side and is permanently attached to the mattress. The *Low Profile CPR* is shown in **Diagram 4** below.

DIAGRAM 4 – CLOSED Position

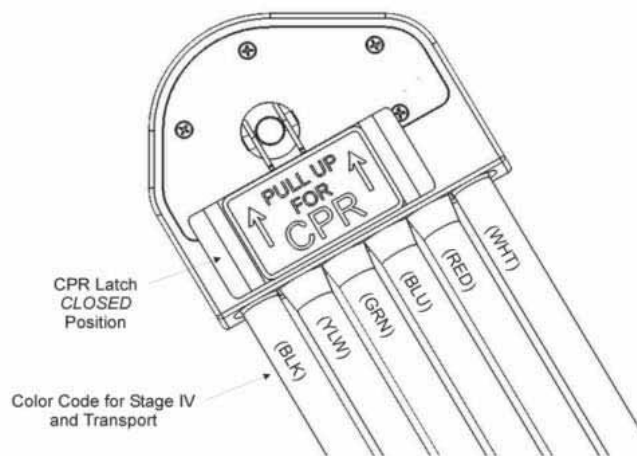

CAUTION!

- Loose hoses can be a tripping hazard. Use caution when transporting the mattress.
- DO NOT immerse the CPR in any liquids.
- Avoid exposure to high heat and/or solvents.
- Protect hoses from sharp or pointed objects that could cut, puncture or tear the material.
- DO NOT attempt to repair the CPR. If damaged or not working properly, call SenTech Customer Service at **800-474-4225** or **954-739-4972** for service information.

4.3.2 Setup & Operation

1. Before operating the system, make sure that the CPR Latch is *completely* down in the CLOSED position (See **Diagram 4**).
2. To activate the CPR and rapidly evacuate the air from the mattress, pull the CPR Latch *completely* up to the OPEN position (See **Diagram 5**). Rate of evacuation is dependent on the weight of the patient.
3. To resume normal operation of the mattress, push the CPR Latch *completely* down to the CLOSED position.

DIAGRAM 5 – OPEN Position

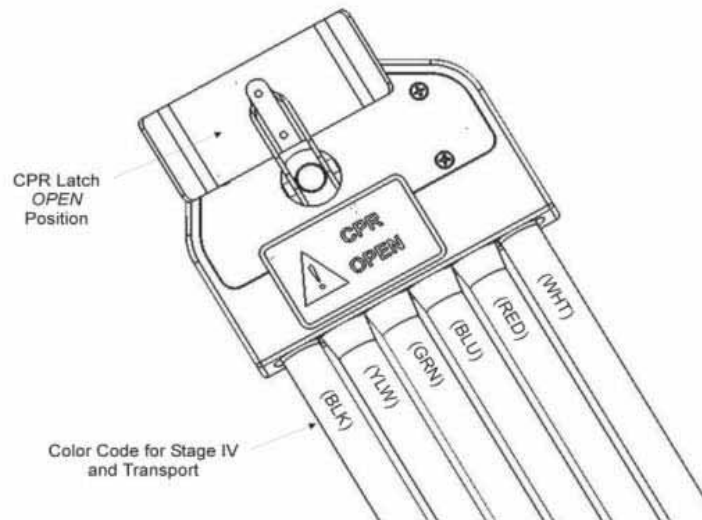

4.3.3 CPR Trouble Shooting Guide –

Problem	Cause	Solution
1. CPR Leaks.	<ul style="list-style-type: none"> a) CPR Latch is not completely down in the CLOSED position. b) Material between the CPR block and the socket is preventing a proper seal. c) Belleville washers are not properly aligned. d) Screw on brass shaft is not tight. e) O-ring(s) are missing/damaged. 	<ul style="list-style-type: none"> a) Make sure the CPR Latch is <i>completely</i> down in the CLOSED position. b) Make sure that nothing is between the CPR block and the mattress shell that is preventing full closure of the CPR, e.g., sheet/blanket. c) Open CPR latch, loosen screw, align washers onto brass shaft, and retighten screw so that head of screw contacts brass shaft. Close CPR latch. d) Open CPR latch and re-tighten screw. Close CPR latch. e) Contact SenTech Customer Service at 800-474-4225 or 954-739-4972 for service information.
2. CPR loose when latch is in the CLOSED position.	<ul style="list-style-type: none"> a) Screw on brass shaft is not tight. b) CPR components are missing or improperly installed. 	<ul style="list-style-type: none"> a) Tighten screw. b) Refer to Section 4.3.5 below.

4.3.4 CPR REMOVAL/INSTALLATION –

The CPR is permanently attached to the mattress and should *not* need to be removed. However, if necessary, it can be removed and reinstalled by following the directions below:

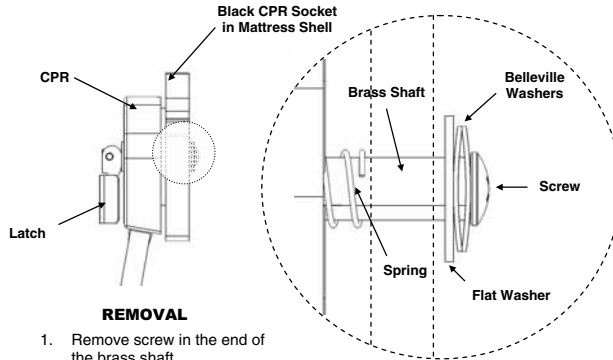

REMOVAL

1. Remove screw in the end of the brass shaft.
2. Remove two (2) Belleville washers.
3. Remove flat washer.
4. Slide CPR assembly out of the CPR socket.
5. Remove the spring.

INSTALLATION

1. Place Spring on the brass shaft of the CPR.
2. Slide brass shaft through the hole in the CPR socket.
3. With latch in open position, align two holes in CPR block with two screws (with spacers) on CPR socket.
4. Squeeze CPR block and socket together and place the flat washer onto the brass shaft.
5. Place the two (2) Belleville washers onto the brass shaft, as noted.
6. Thread the screw into the end of the brass shaft. Tighten ensuring that the washers are centered on the brass shaft and head of screw contacts brass shaft.

5.0 MAINTENANCE AND CLEANING –

IMPORTANT! All disinfection should be done with a "hospital-grade" disinfectant registered with the Environmental Protection Agency (EPA) and in accordance with the manufacturer's specified instructions. Check manufacturer's instructions before use.

5.1 Electrical Controller:

The electronic controller is easy to maintain:

5.1.1 Fuse Replacement:

CAUTION! Only use *UL-Approved* fuses that have the same rating as specified (See **Section 7.0**). Using fuses with higher ratings could result in damage and/or injury.

One (1) replacement fuse is provided with your controller and is located in the compartment on the electrical cord socket. To replace a fuse:

1. Ensure the power switch is in the OFF position.
2. Remove the power cord from the electrical socket on the side of the controller.
3. Using a small sized flat-head screwdriver, pry the fuse holder away from the socket and slide it out of the socket.
4. Remove the "blown" fuse from the fuse holder clip and discard.
5. Remove the spare fuse from the storage compartment and install it into the fuse holder clip (See Diagram Below):

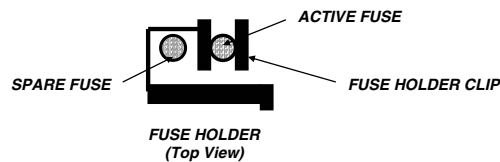

6. Push the fuse holder completely back into the electrical socket until it "snaps" into place.

NOTE: The fuse holder must be properly oriented to slide in correctly. Do not force!

7. Replace power cord and turn on the controller.

5.1.2 Filter Maintenance:

The microprocessor in the controller is programmed to notify you to clean the filters after ~ 800 hours of use (See the Filter Maintenance screen below).

FILTER MAINTENANCE SCREEN



It is very important that you clean the filter when notified. To clean the filter:

1. Unplug the electronic controller.
2. On the bottom of the unit, there are two (2) filter housings:
 - White – Air Intake Filter
 - Black – Cooling Fan Filter
3. Remove the filter grill covers and remove the filters. DO NOT unscrew the filter assembly.
4. Clean the filters by washing in a mild detergent and allow to air dry.
5. Insert the filters into the filter housing and replace the grill covers.
6. If the filters cannot be cleaned, or become damaged, contact SenTech Customer Service for replacement filters.

IMPORTANT! Good filter maintenance is critical in keeping your THERA-TURN controller in optimal operating condition. Failure to keep the filters clean will result in system downtime and increased repair costs

- 5.1.3** The exterior of the controller and CPR assembly should be periodically wiped down with cloth dampened with disinfectant.

CAUTION! DO NOT spray disinfectant directly on the electrical controller, or immerse the controller in any type of liquid. This could result in a severe electrical hazard.

- 5.1.4** Before plugging in the controller, check the power cord for electrical hazards, e.g., cuts, exposed wires, worn insulation, etc. If hazards are present, take the controller out of operation immediately and contact SenTech Customer Service

- 5.1.5** To ensure optimal performance of your MILLENNIUM system, calibration should be verified every 12 months. Contact SenTech Customer Service for calibration information.

5.2 Coverlet:

5.2.1 Washing and Disinfecting

If there are visible signs of body fluids and/or substances present, coverlets should be washed between patients. Coverlets can be machine-washed using chlorine bleach (50-150ppm) or an *intermediate level* disinfectant, such as ProTech¹. Bleach and disinfectant should be used according to the manufacturer's instructions. To determine the amount of bleach or disinfectant to use, determine the amount of water in the washer and then follow the *manufacturer's dilution instructions*. Soak the coverlet in the disinfectant or bleach during the wash cycle. Rinse thoroughly in clean water and dry before use.

NOTE! 2.5 ounces of bleach per 10 gallons of water is approximately 100ppm of available chlorine.

CAUTION! DO NOT dry the coverlet using the "heat" cycle. Air-dry, or select a low or "non-heat" dry cycle, e.g., air fluff.

5.2.2 Washing Alternative

If there are no visible signs of body fluids and/or substances present, the coverlet can be sanitized between patients. To sanitize the coverlet:

1. Apply chlorine bleach, or an intermediate level disinfectant at the appropriate dilution (See **Section 5.2.1**) to the upper surface of the coverlet. Bleach/disinfectant may be applied either by spraying or by hand application.
2. Ensure surface is completely covered with the bleach/disinfectant.
3. Allow bleach/disinfectant to remain in contact with the surface according to the manufacturer's instructions.
4. Remove bleach/disinfectant and rinse.
5. Allow to air dry before use.

5.3 Outside Shell:

Wipe down with disinfectant, ensuring that all surfaces come in contact with the disinfectant. Rinse off with a clean damp cloth and allow to air dry.

5.4 Air Cell Assembly:

CAUTION! DO NOT machine wash or dry the air cells.

The air cell assembly does not routinely need to be cleaned or disinfected between patients.

IMPORTANT! DO NOT disassemble the THERA-TURN MILLENNIUM PLUS mattress, unless cleaning/disinfection is required.

If cleaning/disinfection is required, disassemble the mattress using the color-coded zippers.

IMPORTANT! DO NOT disconnect the hoses from the air cells.

1. ProTech[®] is a tuberculocidal disinfectant cleaner and a registered trademark of Central Solutions, Inc.

5.5 Foam Mattress:

The foam mattress is fully enclosed in a nylon-urethane cover and should not require cleaning. However, if it does become “visibly” soiled, it may be wiped down with disinfectant, ensuring that all surfaces come in contact with the disinfectant. Wipe off with a clean damp cloth and allow to air dry

5.6 CPR:

The exterior of the CPR can be periodically wiped using a cloth dampened with disinfectant.

6.0 TROUBLESHOOTING GUIDE –

Problem	Cause	Solution
1. Alarm is on.	The alarm is activated if the air cells do not reach programmed pressure in approximately 20 minutes. This is usually an indication of an air leak in the system. The display screen will indicate which section is leaking.	<ul style="list-style-type: none"> a) Check the CPR connections (See Section 4.3) b) Be sure all hoses are properly connected to the controller. c) Check all hoses along the inside of the mattress. Each hose should be tightly connected. d) Check each air cell to ensure there are no leaks. (It will be easier to detect a possible leak if you place the system in the MAX FIRM mode). e) Once the leak has been resolved, the alarm light will automatically turn off after three cycles. To reset the system more quickly, turn the power off and then on again to reset.
2. Patient is sinking or “bottoming out” while lying flat.	The pressures may be set too low for the patient’s weight.	Increase bed pressure. An increase of 3-5 mmHg is usually sufficient. However, wait at least one (1) full cycle before determining if the pressure increase was sufficient.
3. The pressure setting was increased, but the pressure does not appear changed.	The AUTOSET key may have been pressed by mistake which would “overwrite” all customized settings.	Re-enter pressures needed. DO NOT press AUTO SET.
4. Air is not constantly flowing into the Low Air Loss Coverlet.	The internal pump gives priority to the air cells in the mattress. Once the air cells are inflated to the selected pressure, air will then be directed to the coverlet.	Allow air cells to reach pressure.
5. Display readings appear scrambled.	Power surges can cause the controller to temporarily malfunction.	Turn controller power off for 5 seconds, then on again to reset.

6.0 TROUBLESHOOTING GUIDE (CONTINUED) –

Problem	Cause	Solution
6. Controller is inoperable.	a) May be caused by a power surge substantial enough to overload the internal circuitry. b) May be caused by internal damage.	a) Check fuse on power cord socket by opening the fuse compartment. NOTE: If you need to replace the fuse, there is a spare 3.15A fuse in the fuse compartment. b) Call SenTech Medical Systems, Inc. at 800-474-4225.
7. CPR hoses become disconnected from exterior block.	Excessive force applied to hose connections.	See Section 4.3.

7.0 PRODUCT SPECIFICATIONS –

Electronic Controller –

Physical Dimensions:

Height (Inches)	12.1
Width (Inches)	14.5
Depth (Inches)	6.0
Weight (Pounds)	21

Electrical Parameters:

US and Canada:

UL2601 Classification Class I

Type B



Power Requirements

120VAC, 60Hz

Fuse

3.15A, 250V, Fast Acting (*UL-Approved*)

Maximum Current

< 1.0A

Ground

Protective Earth



Europe:

Power Requirements

240VAC, 50Hz

Fuse

1A, 250V, Fast Acting

Maximum Current

< 0.5A

Operating Parameters:

Weight Range (Pounds):

Millennium 3 80-500

Millenium Plus 80-995

Height Range (Inches)

50-78

Environmental Conditions:

Operating Conditions:

Ambient Temperature (°C) +10 to +40

Relative Humidity (%) 30 to 75

Atmospheric Pressure (hPa) 700 to 1060

Storage/Shipping Conditions:

Ambient Temperature (°C) -20 to +70

Relative Humidity (%) 10 to 100

Atmospheric Pressure (hPa) 500 to 1060

Mattress Replacement (Fully-Inflated) –

Physical Dimensions

Height (Inches) 8

Width (Inches):

Millennium 3 36

Millenium Plus 42, 48, 54 & 60

Length (Inches) 80

Weight (Pounds) 24 - 45

8.0 WARRANTY INFORMATION -

LIMITED WARRANTY

SenTech Medical Systems, Inc. ("SenTech") warrants each of its products to perform in accordance with established specifications for the following time periods, starting from date the product was shipped from the SenTech facility.

Stage IV & Millennium Systems

Compressor Pump: 3 Years

Electronic Controller: 2 Years

Soft Goods: 1 Year

Primary Care, Sentry, Express & Air Chair Systems

Compressor Pump: 2 Years

Electronic Controller: 1 Year

Soft Goods: 1 Year

Battery: 6 Months

Recliner Chair: 2 Years

During the warranty period, SenTech will repair or replace at no charge any products that are not performing in accordance with established specifications, unless the problem/failure is due to (1) customer damage, negligence and/or misuse or (2) unauthorized repairs. Items not covered under warranty include, but are not limited to: stains, punctures, cuts, damages to electrical cords, rips or tears, dents and/or lost/missing parts.

All products returned for warranty repairs must be assigned a return authorization number, prior to return. Returns should include information describing the problem and/or requested repair and be sent to SenTech by prepaid transportation. SenTech will return the repaired/replaced product at no charge. Warranty repairs do not extend the length of the warranty period. During the warranty period, SenTech will provide one Bio-Med test at no charge, excluding shipping/handling.

Neither SenTech, its officers, directors, employees or agents shall be liable for consequential or other damages, including but not limited to personal injury, loss, or any other expense, directly or indirectly arising from the use of its products. The sole remedy for breach of the limited warranty granted herein shall be repair or replacement of the SenTech products.

All product specifications are subject to change without notice.

9.0 PRODUCT RETURN –

The MILLENNIUM SYSTEMS have been designed to provide you with years of trouble-free service. However, in the event that the product needs to be returned for any reason, such as calibration or repair, the following return procedure must be followed. Failure to follow this procedure may result in unnecessary delays.

Return Procedure -

Before returning a product to SenTech:

1. Contact Customer Service and obtain a **Return Material Authorization (RMA)** number.
2. Package the product in its “approved” packaging.
3. Reference RMA number on the shipping container and shipping documents.
4. Ship product to the attention of Customer Service at the following address:

SenTech Medical Systems, Inc.
5353 NW 35 Avenue
Fort Lauderdale, FL 33309

SenTech Medical Systems, Inc.

5353 NW 35 Ave
Ft. Lauderdale, FL 33309

Phone: 954-739-4972

FAX: 954-739-2779

Web Site: sentechmedical.com

STAGE IV Millennium 3 and STAGE IV Millennium PLUS
are registered trademarks
of SenTech Medical Systems, Inc.
Ft. Lauderdale, FL